

ADMINISTRATIVE APPROVAL 12-6-11  
**APPROVED**



WWW.PLANTCONTAINERS.COM  
 (3) NEOMETRICS OVAL LOW BOWL PLANTERS  
 MODEL NO. NSB-30  
 COLOR: BLACK  
 REFER TO LP1 FOR LOCATION

STATE ROAD 7 (US 441)

LEGEND - INTERLOCKING PAVERS: Paver Systems by Tarmac

PAVER UNIT	PATTERN	NOTES
4x8 Holland Stone	Herringbone	Color - Generation 1 - Adobe mix placed on a 45 degree angle to adjacent sidewalk

- GENERAL NOTES:
- For complete installation & Specification details of pavers contact Paver Systems by Old Castle or equal. (954)944-5222
  - To maintain color consistency, pavers must be installed from several cubes at a time, working vertically through the cube instead of layer by layer. This will ensure subtle blending of any minor color variations between the cubes.
  - ADDITION: Surface Sealer Clear to be applied to ALL Pavers - OPTIONAL. ADJUSTMENT: Surface Sealer Clear to be applied at a rate of 150 sq. ft. per gal. (check cover), or approved equal.

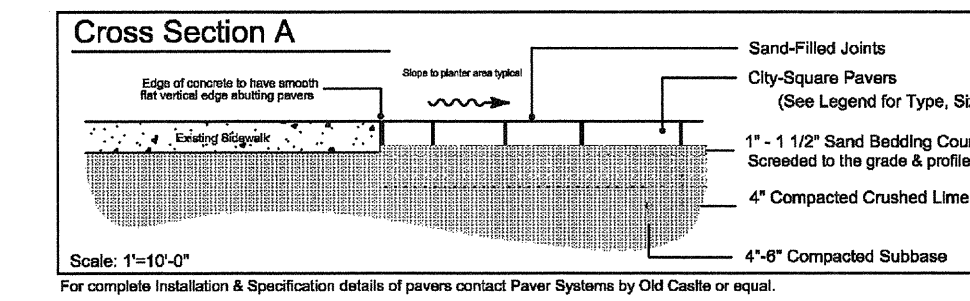

PROPOSED DECORATIVE CONCRETE PAVERS

TYP. BENCH DETAIL  
 NOTE: ACTUAL PRODUCT MAY DIFFER FROM BENCH SHOWN.

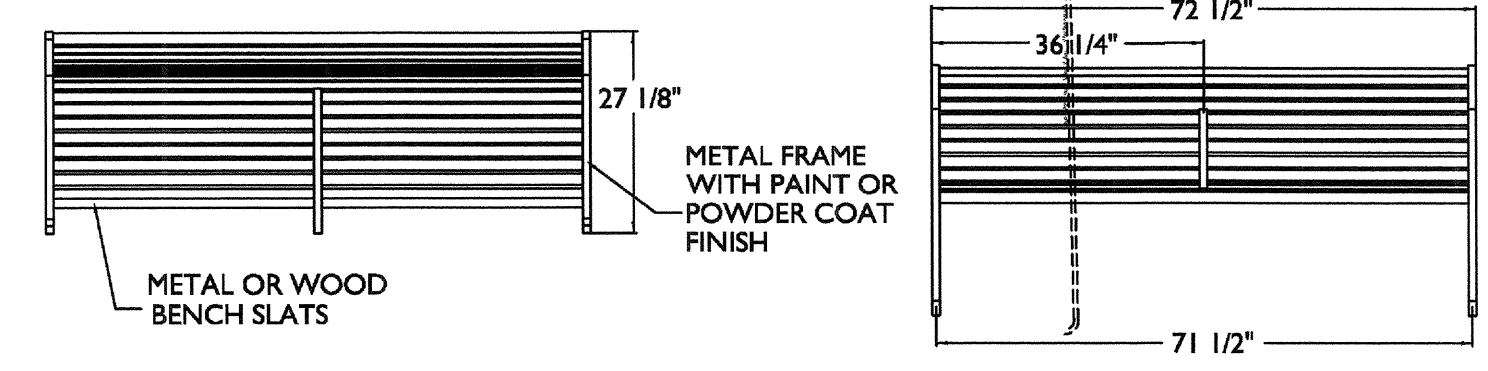

REFER TO MANUFACTURER FOR SHOP DRAWING TO ASSEMBLE AND SECURE

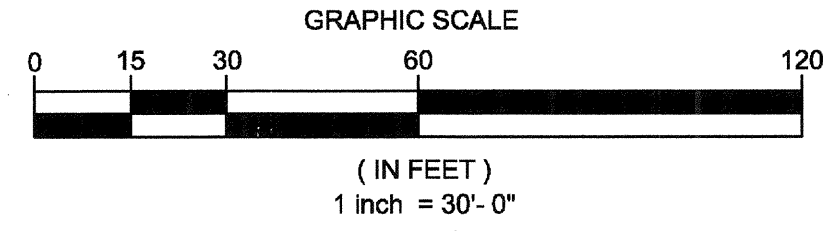
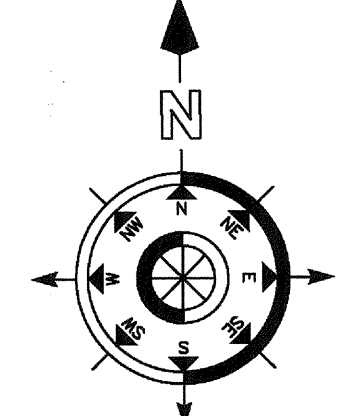

**SUN TECH** Sun-Tech Engineering, Inc.  
 Engineers - Planners - Surveyors

1600 West Oakland Park Boulevard  
 Ft. Lauderdale, FL 33311  
 www.suntecheng.com

Certificate of Auth. # 7097  
 Phone (954)777-3123  
 Fax (954)777-3114

Call 48 hours before you dig in Florida  
 It's the Law!  
 1-800-432-4770  
 FPLAL (305) 347-3900  
 Sunshine State One Call of Florida, Inc.

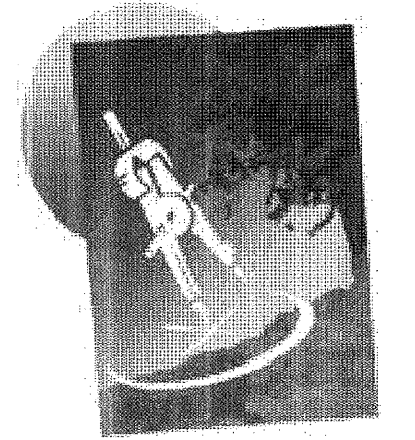
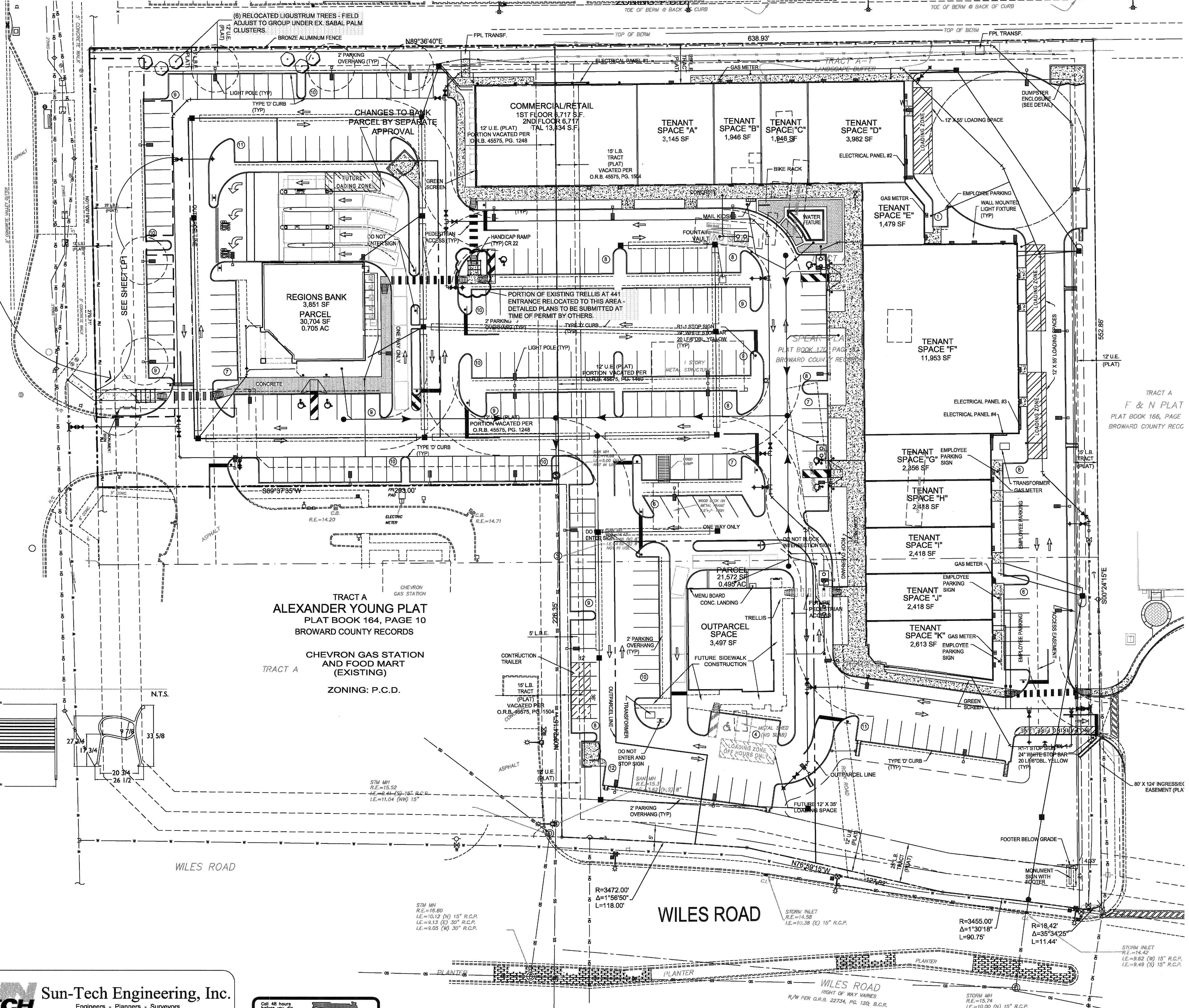

**Lynn Bender Landscape Architecture**  
 5610 Adair Way  
 Lake Worth, FL 33467  
 Phone: 561-644-3237  
 lbenderlarch@gmail.com  
 FL-LA6666715  
 LC26000285

**VILLAGE SHOPPES OF COCONUT CREEK**  
 441 & WILES ROAD COCONUT CREEK, FLORIDA  
 441 WEST BUFFER LANDSCAPE PLAN

No.	Revision/Issue	Date
1	DRC COMMENTS	11/21/11

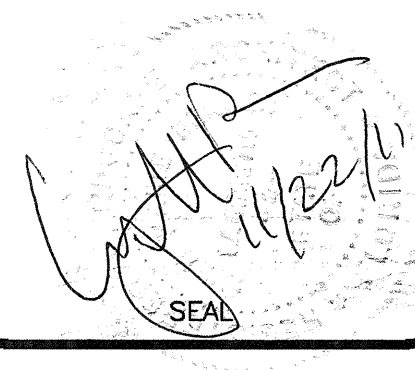

Project	Sheet
Village	LP2
Date	10-26-11
Scale	1" = 10'-0"
	OF 2